

Peak pulse voltage ($T_j=25$; non-repetitive, off-state; FIG.8)	V_{pp}	3	kV
----------------------------------------------------------------------	----------	---	----

ELECTRICAL CHARACTERISTICS (unless otherwise specified)

Symbol	Conditions	Unit	Value	Unit
I_{GT}	$V_D=12V R_L=33$	-	MAX.	10
V_{GT}		-	MAX.	1
V_{GD}	$V_D=V_{DRM} T_j=125$ $R_L=3.3k$	-	MIN.	0.2
I_L	$I_G=1.2I_{GT}$	-	MAX.	20
				35
I_H	$I_T=100mA$		MAX.	15
dV/dt	$V_D=540V$ Gate Open $T_j=125$		MIN.	500
(dI/dt)c	(dV/dt)c=10V/ μs , $T_j=125$		MIN.	2.5
t_{on}	$I_G=20mA I_A=200mA I_R=20mA$ $T_j=25$		TYP.	2.5
t_{off}				25

STATIC CHARACTERISTICS

Symbol	Conditions	Unit	Value	Unit
V_{TM}	$I_{TM}=5A t_p=380\mu s$ $T_j=25$		1.5	V
V_{TO}	Threshold voltage $T_j=125$		0.78	V
R_D	Dynamic resistance $T_j=125$		190	m
I_{DRM}	$V_D=V_{DRM} V_R=V_{RRM}$ $T_j=25$		5	μA
I_{RRM}		$T_j=125$	0.25	mA

THERMAL RESISTANCES

Symbol	Conditions	Unit	Value	Unit
$R_{th(j-c)}$	junction to case (AC)		17	/W
$R_{th(j-a)}$	junction to ambient (AC)		60	/W

ORDERING INFORMATION

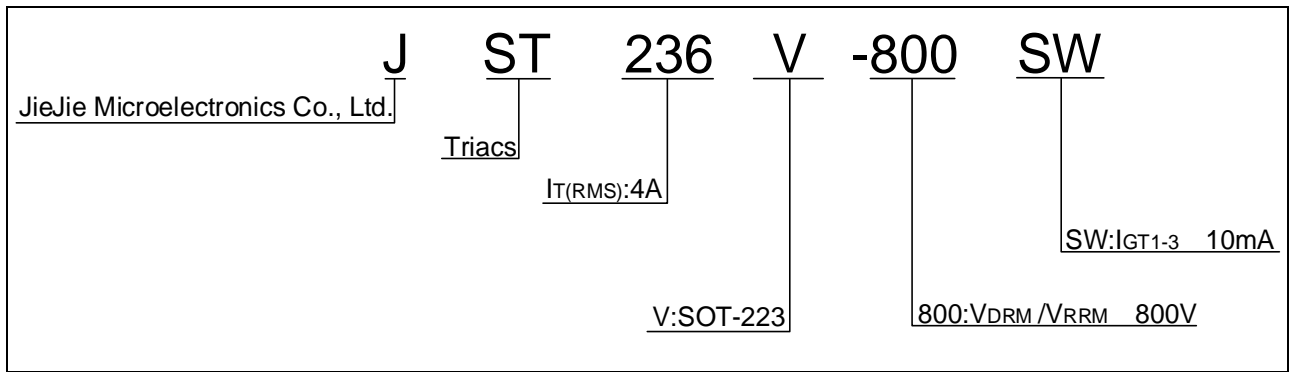

MARKING

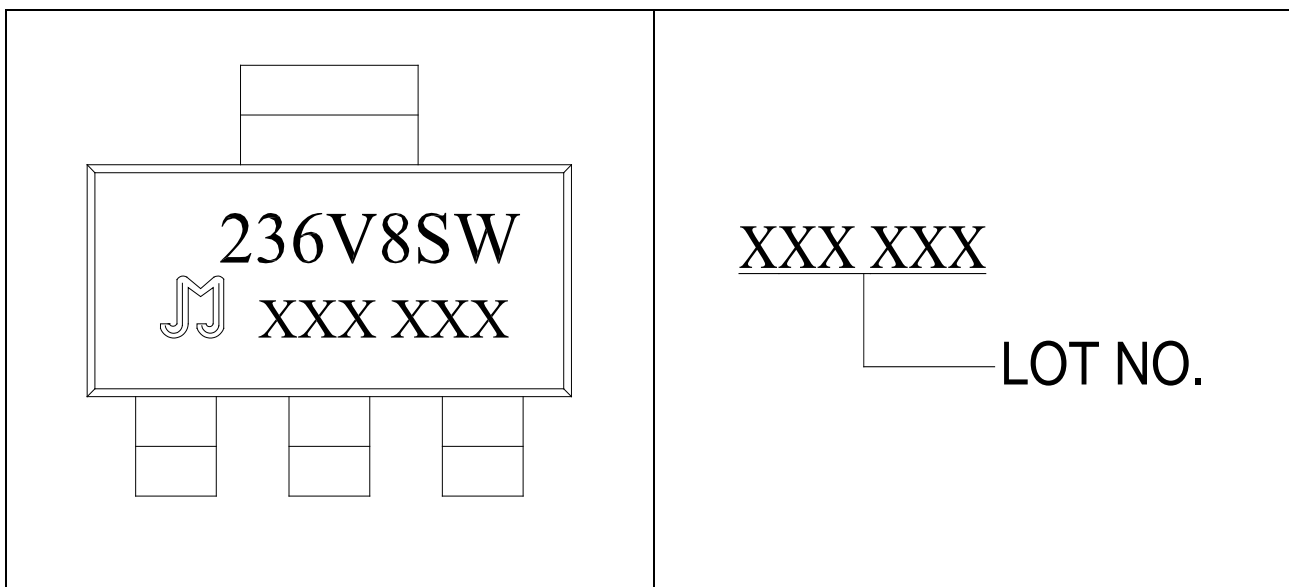

FIG.1: Maximum power dissipation versus RMS on-state current

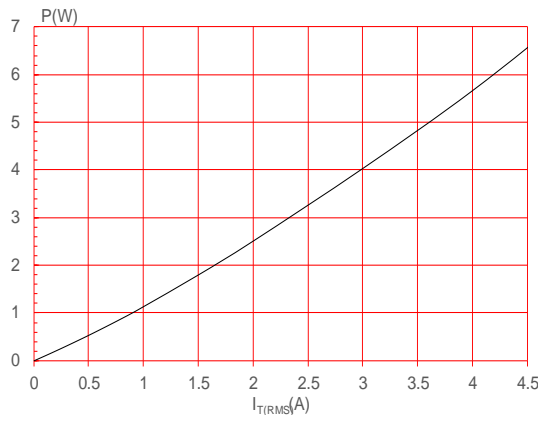

FIG.2: RMS on-state current versus case temperature

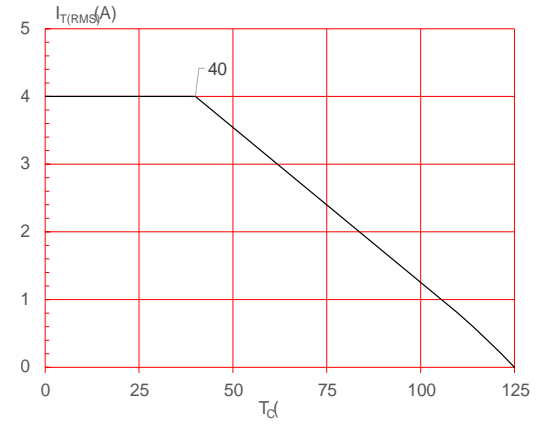

FIG.7: Relative variations of gate trigger current, holding current and latching current versus junction temperature

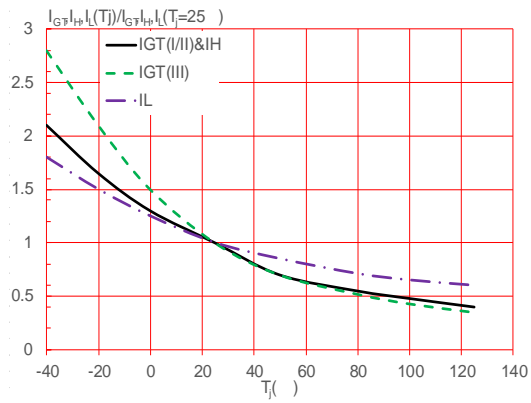
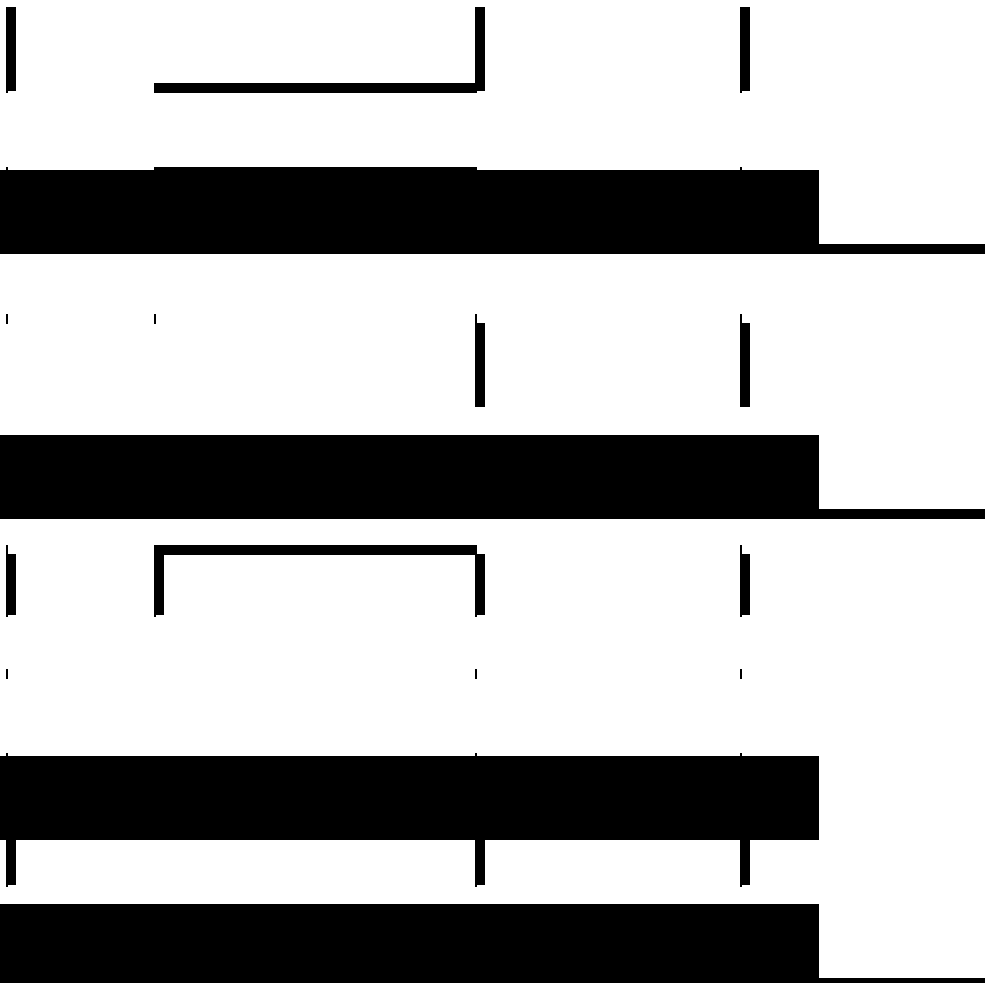
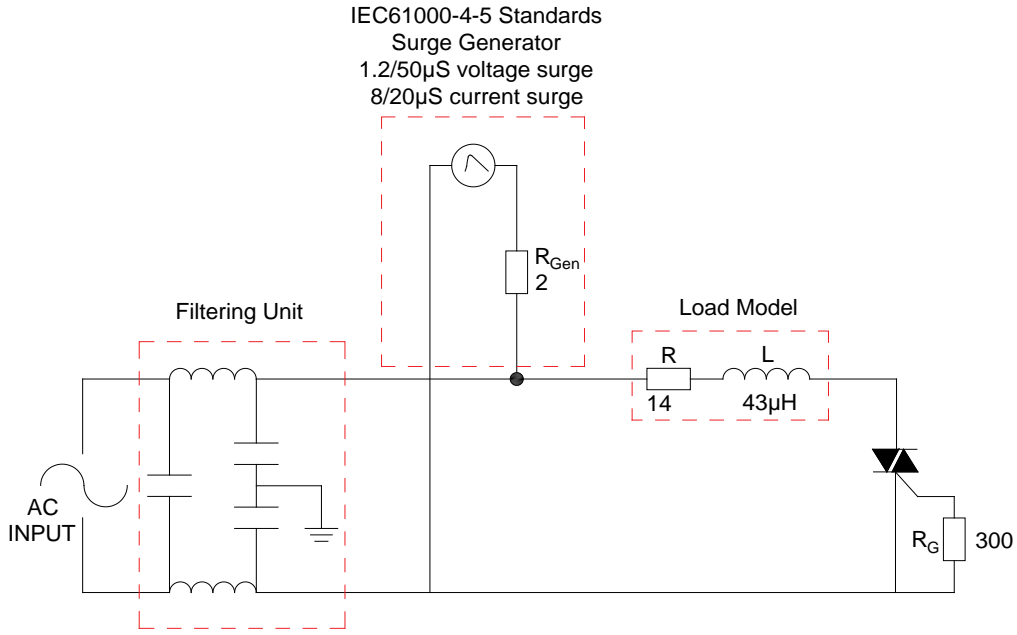

FIG.8 Test circuit for inductive and resistive loads to IEC-61000-4-5 standards



ORDERING INFORMATION

Order	V _{DRM} /V _{RRM} (V)	IGT(A _m)	P _g	Qty (p)	D _{th}
		- -			
JST236A800SW	800	10	SOT-223	4,000	T _g R _e

Revision

Date	Revision	Changes
Apr.11, 2025	A.1.0	Last updated

PACKAGE MECHANICAL DATA

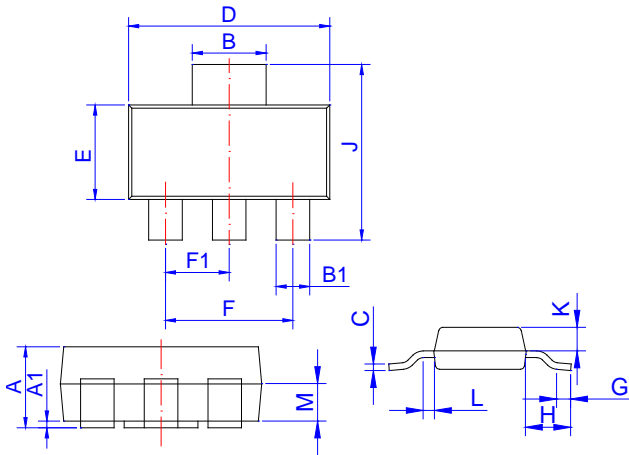

Ref.	Dimensions					
	Millimeters			Inches		
	Min.	Typ.	Max.	Min.	Typ.	Max.
A	1.50	1.60	1.80	0.059	0.063	0.071
A1	0.01	0.06	0.10	0.001	0.002	0.004
B	2.90	3.00	3.10	0.114	0.118	0.122
B1	0.60	0.70	0.80	0.024	0.028	0.031
C	0.22	0.26	0.32	0.009	0.010	0.013
D	6.30	6.50	6.70	0.248	0.256	0.264
E	3.30	3.50	3.70	0.130	0.138	0.146
F	4.40		4.80	0.173		0.189
F1	2.20		2.40	0.087		0.094
G	0.50		1.00	0.020		0.039
H	1.50	1.75	2.00	0.059	0.069	0.079
J	6.70	7.00	7.30	0.264	0.276	0.287
K	0.80		1.00	0.031		0.039
L	0.40		0.80	0.016		0.031
M	0.75		0.95	0.030		0.037

FOOTPRINT SOT223 (dimensions in mm)

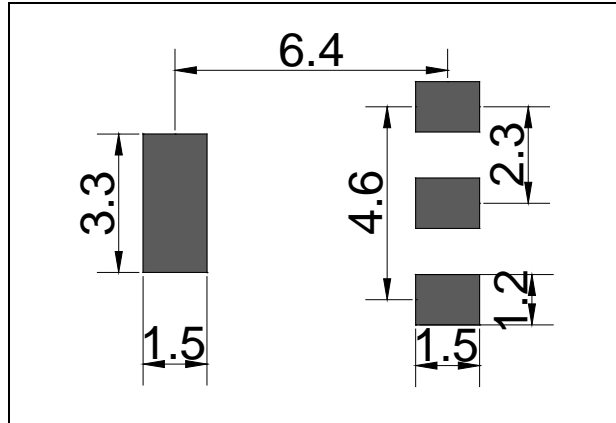

DELIVERY MODE

Dimensions

Ref.

-

Information furnished in this document is believed to be accurate and reliable. However, Jiangsu JieJie Microelectronics Co., Ltd. assumes no responsibility for the consequences of use without consideration for such information nor use beyond it. Information mentioned in this document is subject to change without notice, apart from that when an agreement is signed, Jiangsu JieJie complies with the agreement.

Products and information provided in this document have no infringement of patents. Jiangsu JieJie assumes no responsibility for any infringement of other rights of third parties which may result from the use of such products and information. This document supersedes and replaces all information previously supplied.



is a registered trademark of Jiangsu JieJie Microelectronics Co., Ltd.

Copyright © 2025 Jiangsu JieJie Microelectronics Co., Ltd. All rights reserved.