

ORDERING INFORMATION

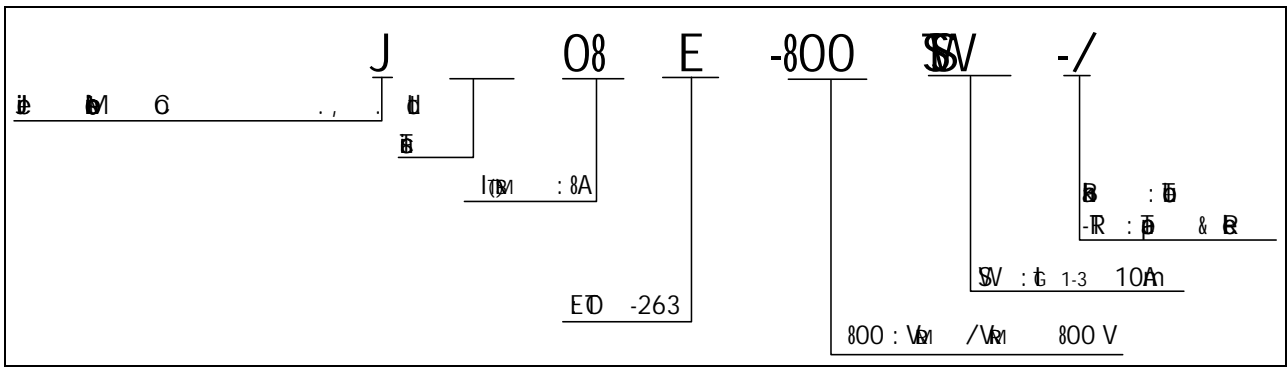

MARKING

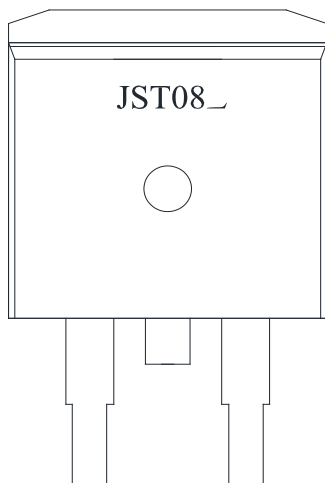
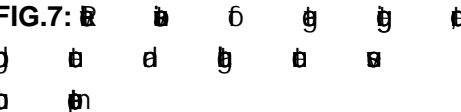
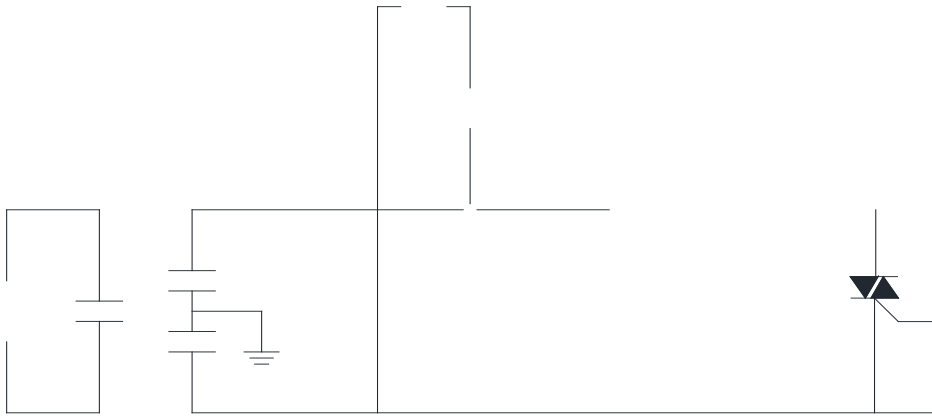

FIG.1:

FIG.7: 



ORDERING INFORMATION

Order code	Voltage V_{DRM}/V_{RRM} (V)	IGT(mA)	Package	Base qty. (pcs)	Delivery mode
		- -			
JST08E-800SW	800	10	TO-263	50	Tube
JST08E-800SW-TR				800	Tape & Reel

Document Revision History

PACKAGE MECHANICAL DATA

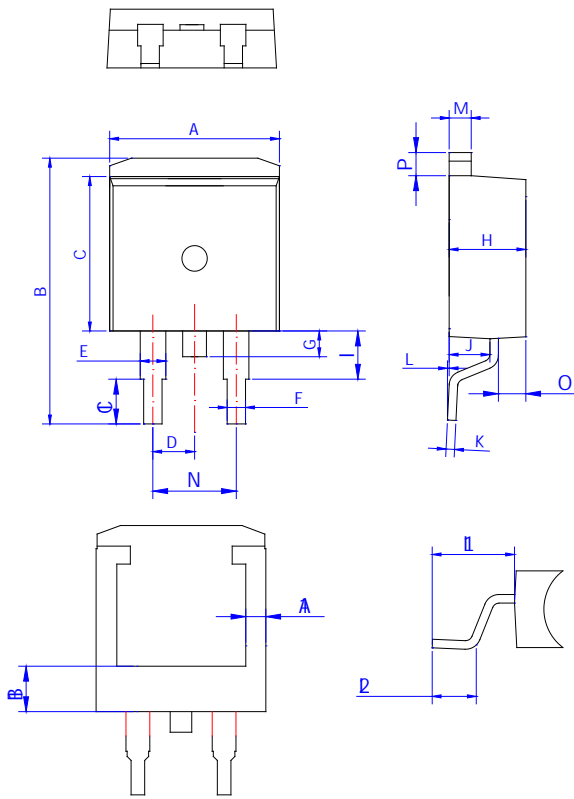

R	B					
	M			B		
	M	φ	M	M	φ	M
A	9.90		10.20	0.390		0.402
A	0.80		1.20	0.031		0.047
B	14.70		15.80	0.579		0.622
B	2.15		2.55	0.085		0.100
C	9.40		9.60	0.370		0.378
C	2.40		2.80	0.094		0.110
D	2.40		2.70	0.094		0.106
E	1.20		1.50	0.047		0.059
F	0.75		0.85	0.029		0.033
G	1.00		1.50	0.039		0.059
H	4.40		4.70	0.173		0.185
I	1.80		2.20			
J	2.30		2.70	0.091		0.106
K	0.38		0.55	0.015		0.022
L	0	0.10	0.25	0	0.004	0.010
L	4.65		5.05	0.183		0.199
φ	1.90			0.075		
M	1.25		1.35	0.049		0.053
N	4.80		5.20			
O	1.30		1.50			
P	1.20		1.50	0.047		0.059

FOOTPRINT-TO-263(dimensions in mm)

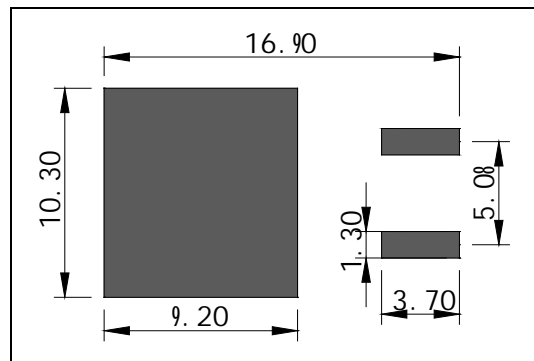

DELIVERY MODE

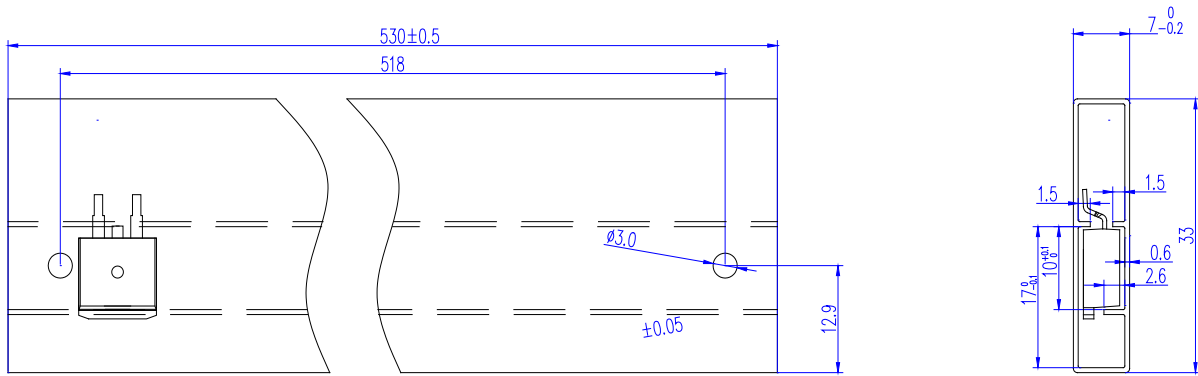

PACKAGE

