



DESCRIPTION:



MAIN FEATURES:

ABSOLUTE MAXIMUM RATINGS

Parameter		Symbol	Value	Unit
		)		
		)		
		)		
		)		
		)		



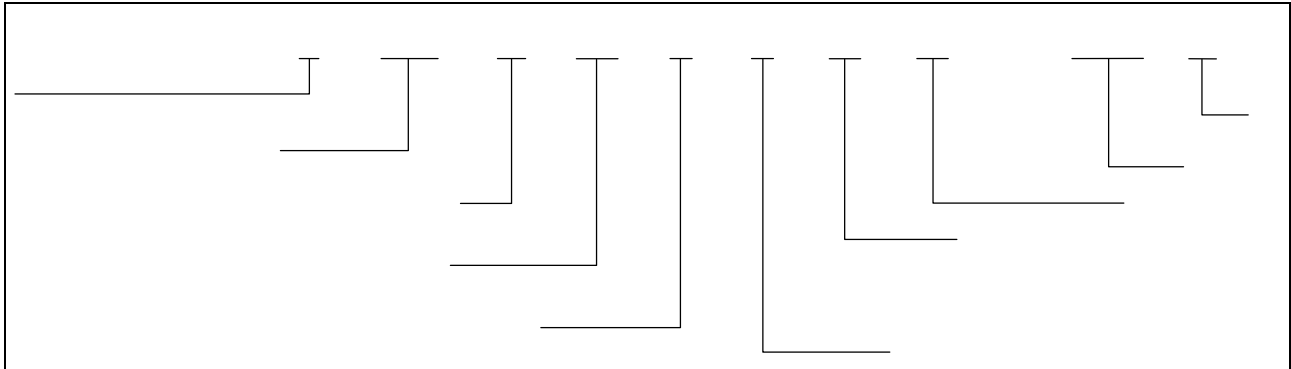

**ORDERING INFORMATION**

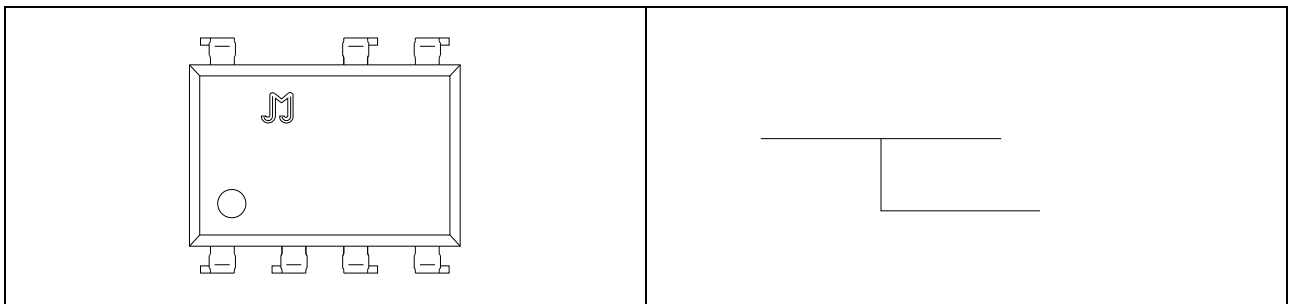

Packing Quantity	
Option	Quantity
DIP	0 Units/Tube
SMD	1200 Units/Reel

**MARKING**



## Characteristics Curves

FIG.1:

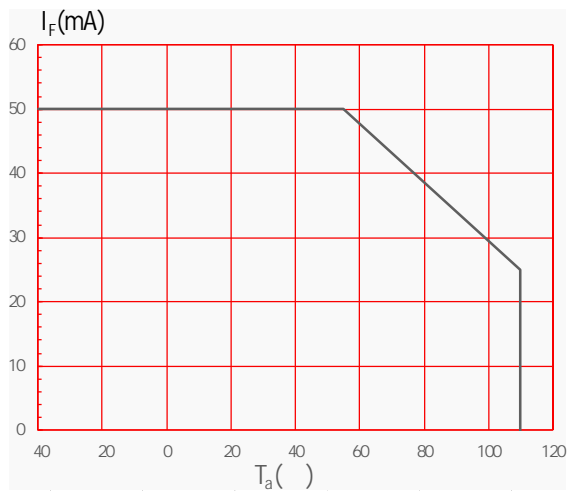

FIG.2:



FIG.7:

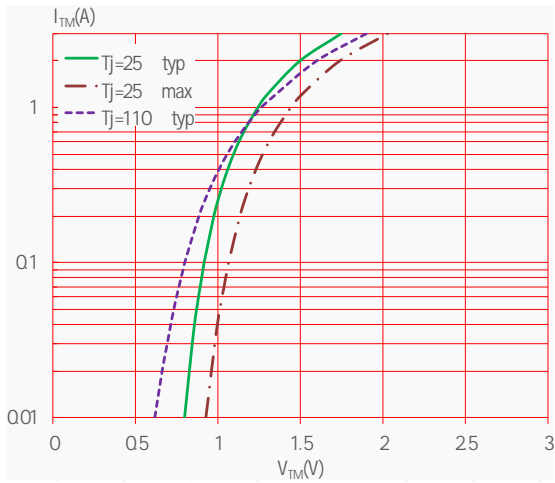
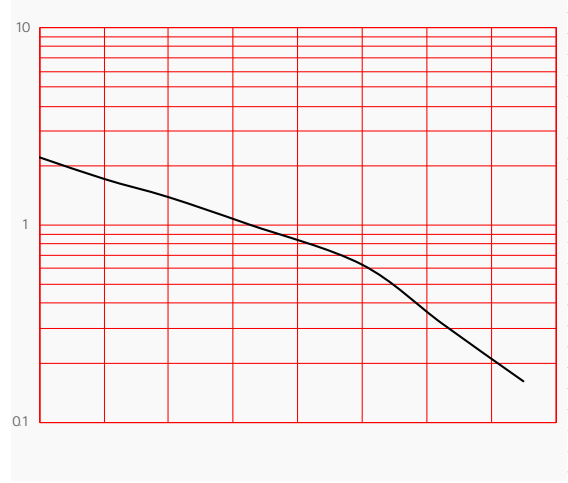

FIG.8:



TEST CIRCUITS

FIG.10:

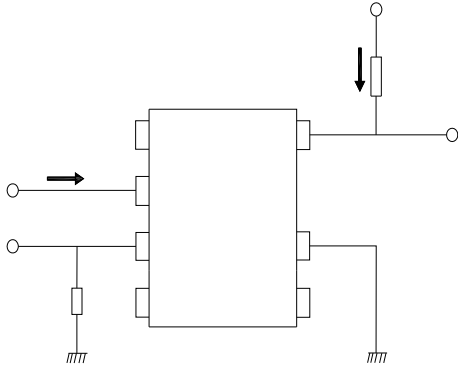
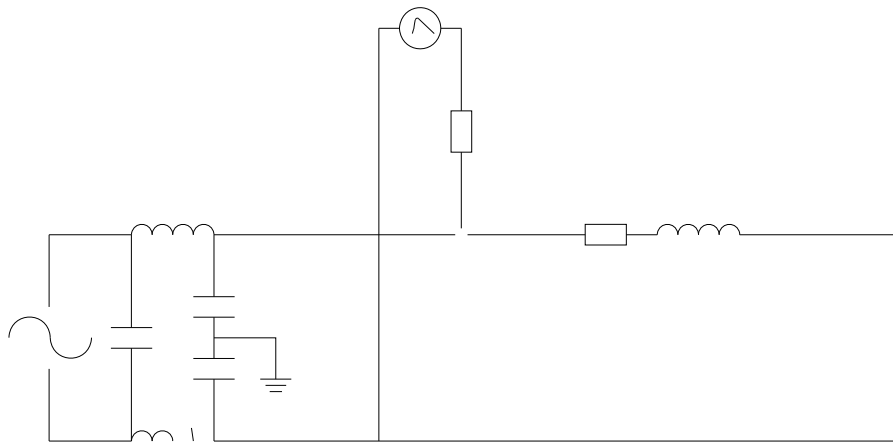

FIG.11:

FIG.12:

5 F H





RECOMMENDED SOLDER MASK (Dimensions in mm unless otherwise stated)

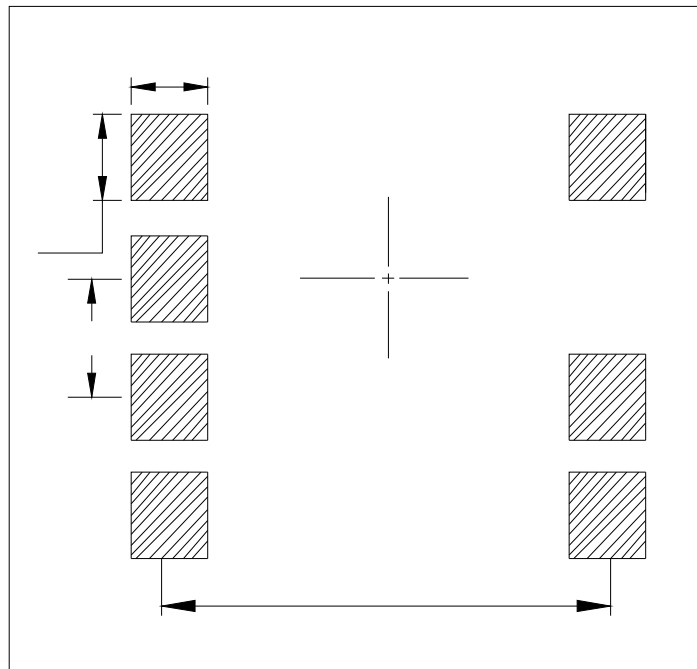

TUBE SPECIFICATIONS (Dimensions in mm unless otherwise stated)

Standard DIP

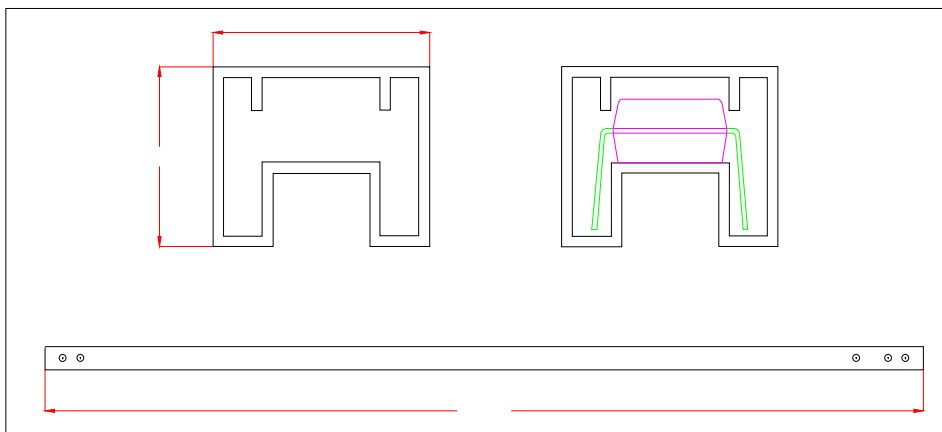

**CARRIER TAPE SPECIFICATIONS (Dimensions in mm unless otherwise stated)**

Option S/L

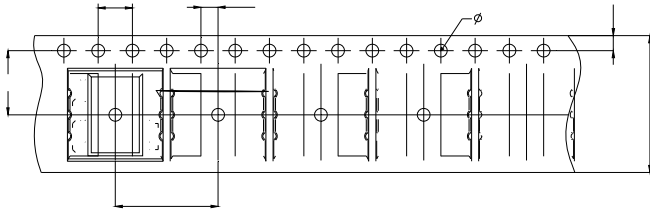

REFLOW INFORMATION

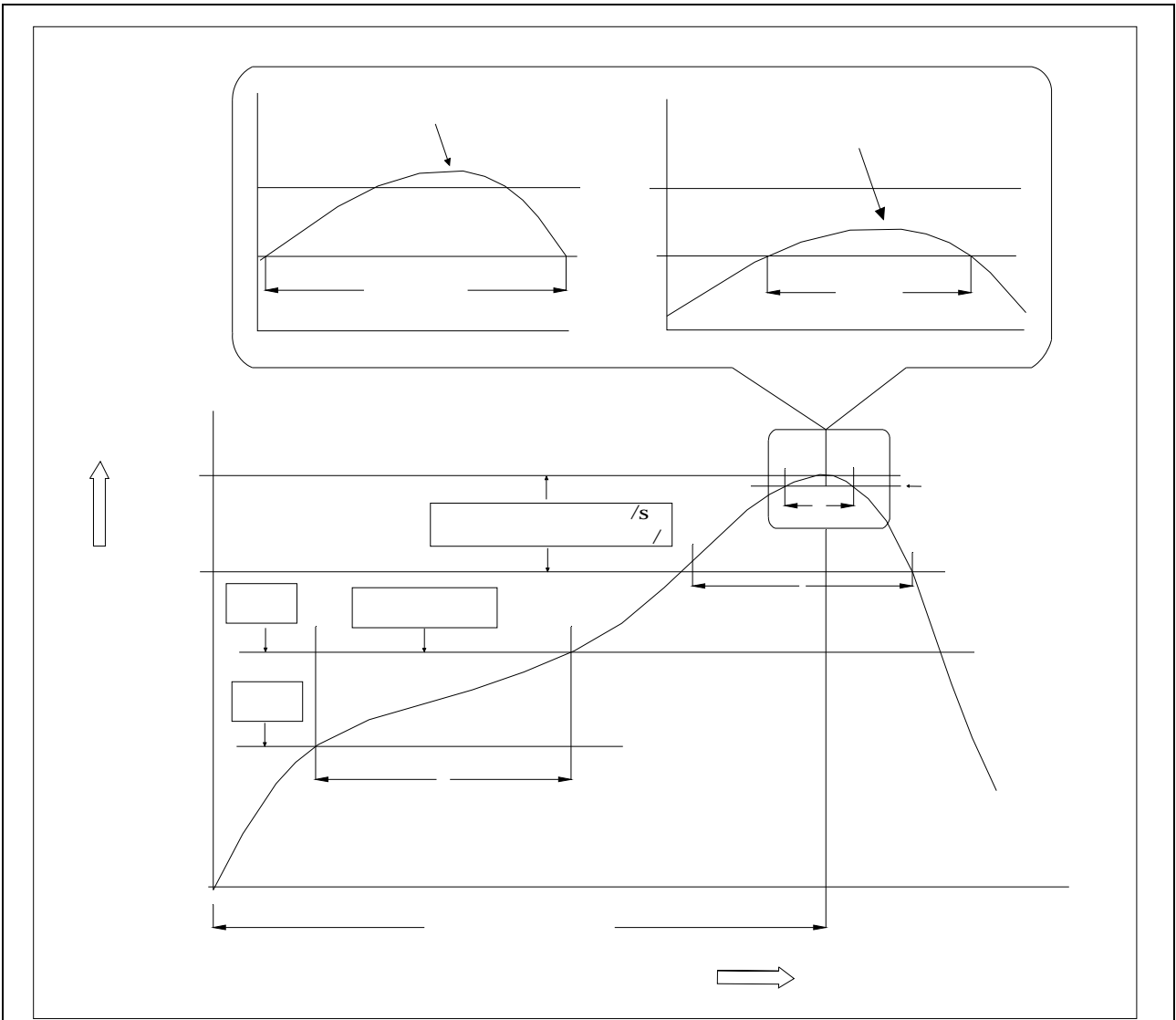

WAVE SOLDERING

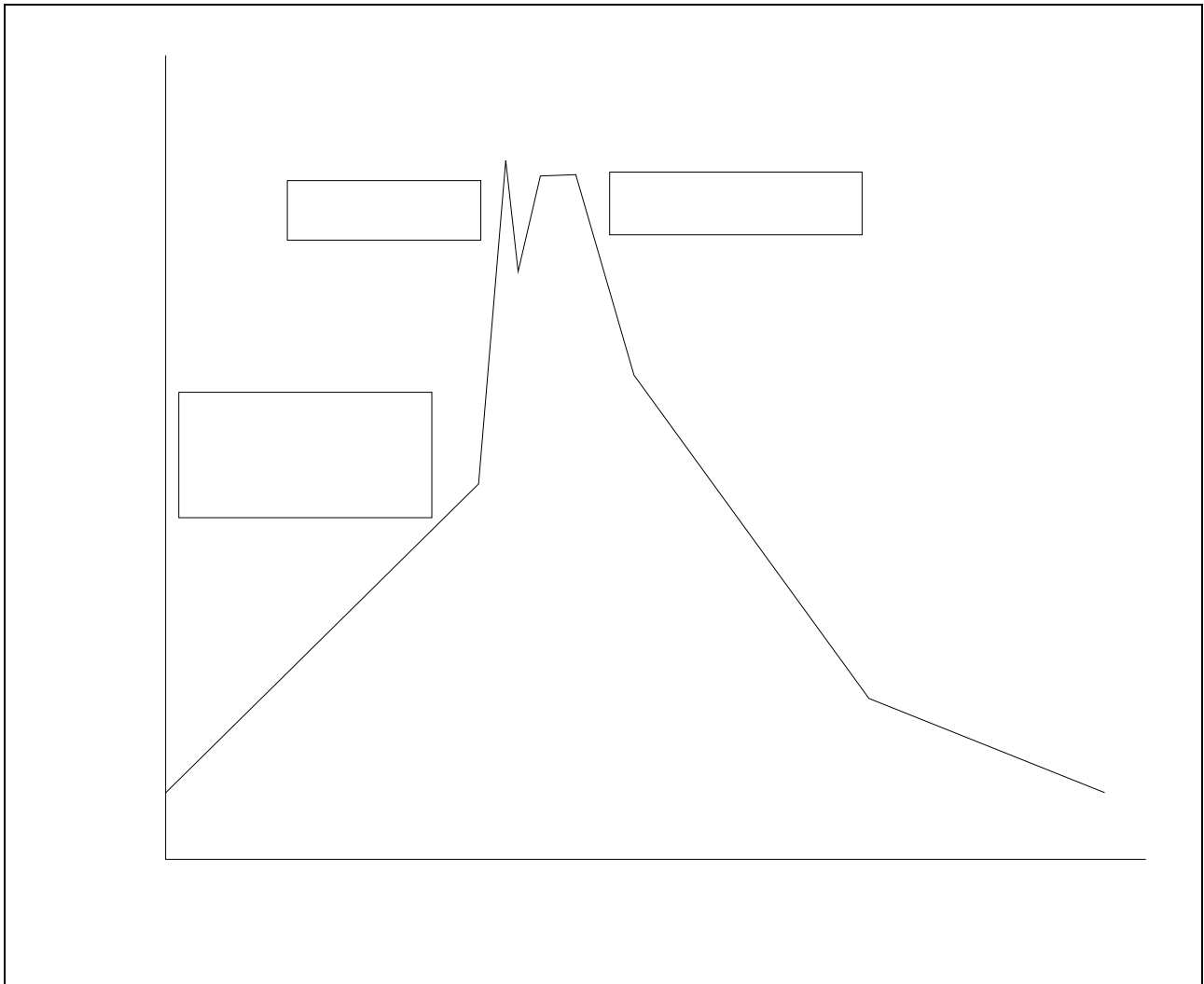

HAND SOLDERING BY SOLDERING IRON

±

