



-, (-, (0, & 5 2 (/ (& 7 5 2 1, & 6 & 2

- 2 & 5 6 H U L H V

' & , Q S X W \$ * D W H ' U L Y H U 3

' H V F U L S W L R Q

7 K H 2 & 5 V H U E R F E I D Q S H O * D \$ V
L Q I U D H P L O G V L R O C W K H P L V Z W H E K
R S W L F B Q S W I R G Q W H J E L D U V Z X C W K
S R Z H R X W S X M J O S O D V, W L S F D F N D J H
Z L W K L I I H O J H D R G V P R S W L R Q V

) H D W X U H V

- x + L J K L V R O D W L R Q 9 5 0 6
- x ' & L Q S X W Z L W K D K L J K V S H H
- x 2 S H U D W L Q J W H P S H U D W X U H
f &
- x 5 D L O W R U D L O R X W S X W
- 5 (\$ & + 5 R + F R P S O L D Q F H
- + D O R J U H Q S W L R Q D O
- 0 6 / F O D V V
- 5 H J X O D S S B U R Y D O V
 - 8 /
 - 9 '(
 - C Q C

\$ S S O L F D W L R Q V

- x , V R O D W H G , * % 7 3 R Z H U 0 2 6)
- x , Q G X V W U L D O , Q Y H U W H U
- x \$ & E U X V K O H V V D Q G ' & P R W R
- x , Q G X F W L R Q + H D W L Q J

6 & + (0 \$ 7 , &

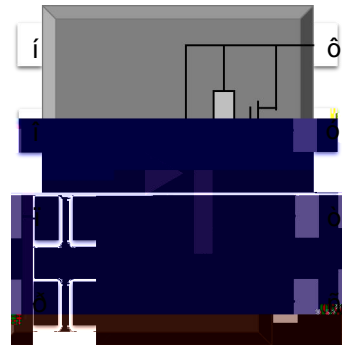

3 , 1 '() , 1 , 7 , 2 1

1 &	9 & &
\$ Q R G I	9 2
& D W K	9 2
1 &	* 1 '

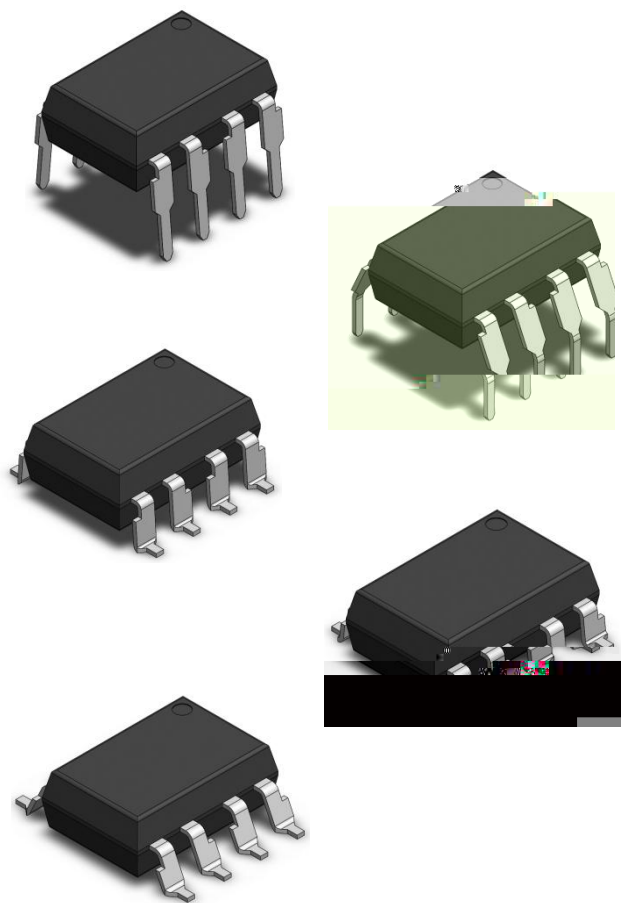

\$%62/87(0\$;,080 5\$7,1*6

3\$5\$0(7(5

6<0%2/

9\$/8(

81,7

1RW

,1387

)RUZDUG &XUUHQW

,)

P\$

3HDN)RUZDUG &XUU

,)3

P\$

3HDN 7UDQVLHQW &X

,) WUDQ

\$

2SHUDWLQJ)UHTXH

I

N+]

5HYHUVH 9ROWDJH

95

9

,QSW 3RZHU 'LVÀVÀVÀ

5 (& 200 (1' (' 23 (5\$7, 21 & 21', 7, 216

3\$5\$0(7(5	6<0%2/ 0,1 0\$;	81,7
2SHUDWLQJ 7HPSHUD\	7\$	f&
6XSSO\ 9ROWDJH	9&&	9
,QSXW &XUUHQW 21	,) 21	P\$
;QSXW 9ROWDJH 2œ		

@À

(/(&75,&\$ / 237,&\$ / &+\$5\$&7(5,67,&6 9&& 9 9((*1' 7\$ f& XQOHVV V\$

3\$5\$0(7(5 6<0%2/ 0,1 7<3 0\$; 81,7 7(67 &21',7,21 127(
6:,7&+,1* &+\$5\$&7(5,67,&6

3URSDJDWLRQ ' 73+/ QV
WR 2XWSXW /R
3URSDJDWLRQ ' 73/+ QV ,) WR P\$
WR 2XWSXW +L &/ Q) 5/ Ÿ
3XOVH :LGWK 'L _73+/ 73/ QV I N+] 'XW\
3URSDJDWLRQ ' W36. QV 7\$ f&
5LVH 7LPH WU QV
)DOO 7LPH WI QV
89/2 7XUQ 2Q 'H W89/2 21 V ,) P\$ 92! 9
89/2 7XUQ 2II 'H W89/2 2)} V ,) P\$ 92 9

&RPPRQ 0RGH 7L

& + \$ 5 \$ & 7 (5 , 6 7 , & & 8 5 9 (6

)LJ)RUZDUG &XUUHQ
YV)RUZDUG 9ROWDJ

)LJ)RUZDUG 9ROWDJ
YV \$PELHQW 7HPSHUD

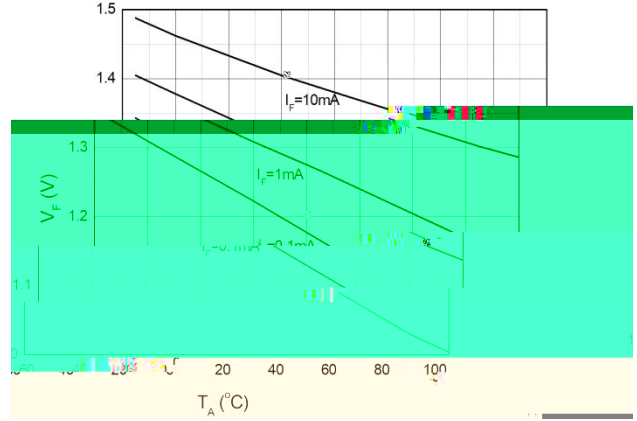
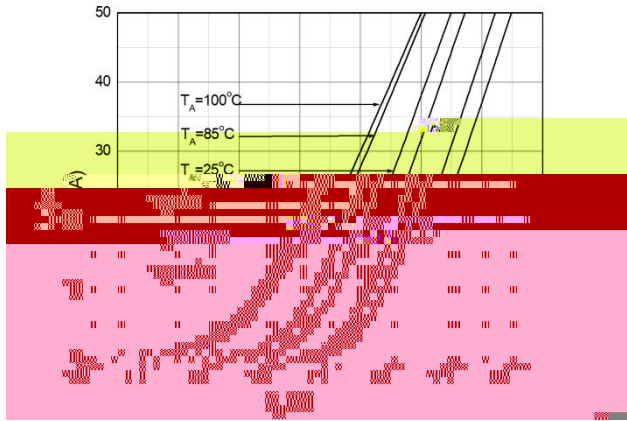

)LJ 6XSSO\ &XUUHQV
YV \$PELHQW 7HPSHUD

)LJ 6XSSO\ &XUUHQV
YV 6XSSO\ 9ROWDJH

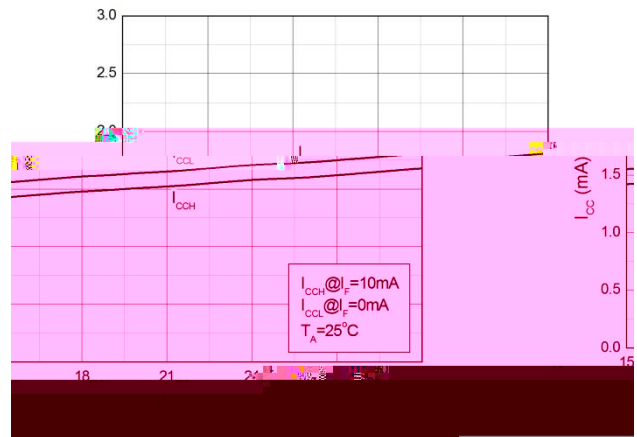
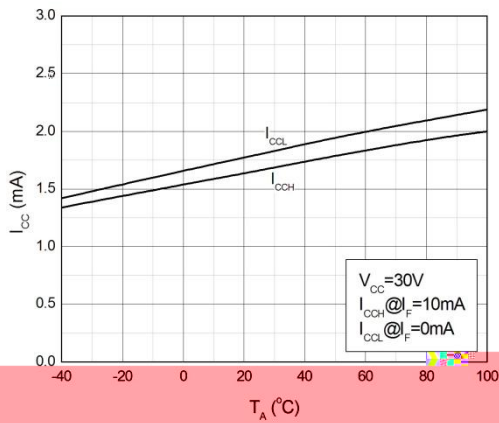

)LJ +LJK /HYHO 2XWSXW
YV +LJK /HYHO 2XWSXW

)LJ /RZ /HYHO 2XWSXW 9
YV /RZ /HYHO 2XWSXW &

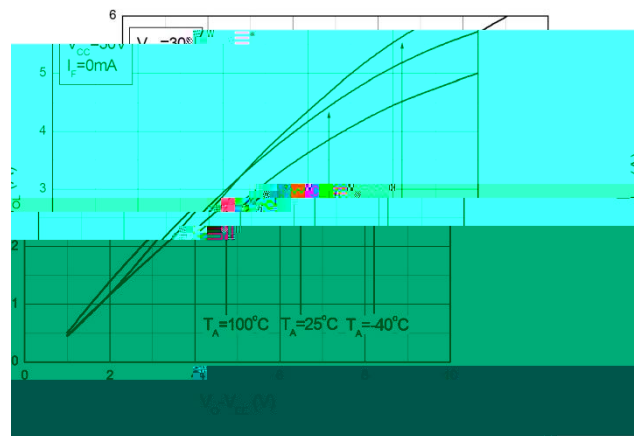
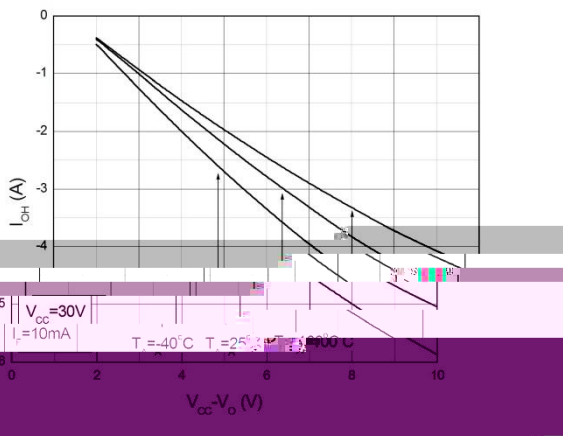

&+\$5\$&7(5,67,& &859(6

)LJ 3URSDJDWLRQ 'H
YV)RUZDUG &XUUHQ

7 (67 & , 5 & 8, 76

)LJ 7HVW & LUFXLWV IRU , 2+

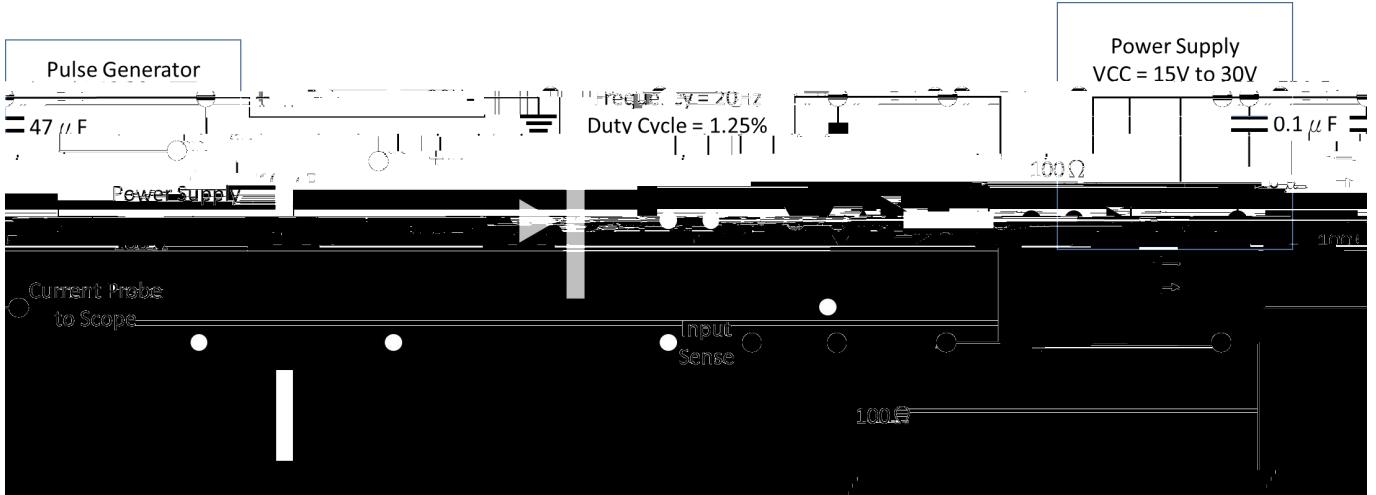

)LJ 7HVW & LUFXLWV IRU , 2/

7 (67 & , 5&8 , 76



7(67 & ,5&8,76

)LJ 7HVW &LUFXLWV IRU &RPPRQ 0RGH 7UDQVLF

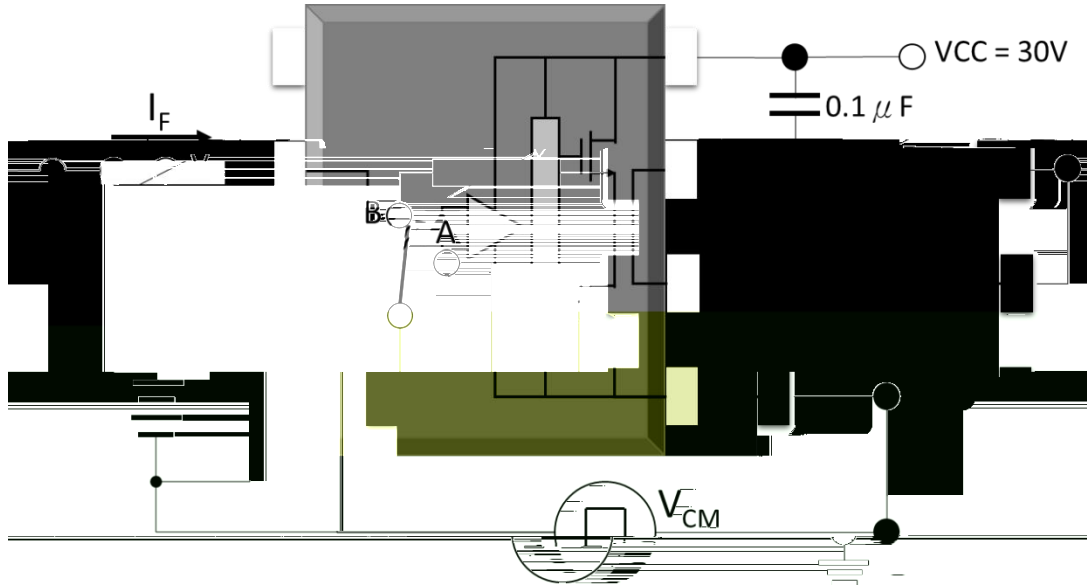

)LJ :DYHIRUPV RI &RPPRQ 0RGH 7UDQVLFHQW , P

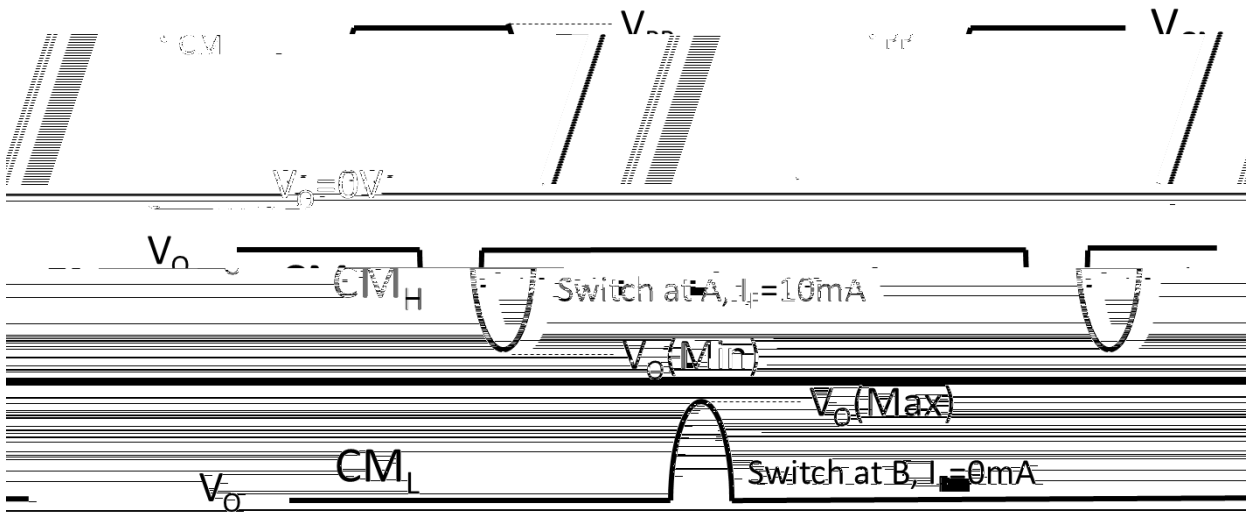

3\$&.\$*(',0(16,216LPHQVLRQV LQ PP XQOHVV RWKHUZI
 6WDQG DUG ',3 ± 7KURXJK +ROH ',3 7\SH

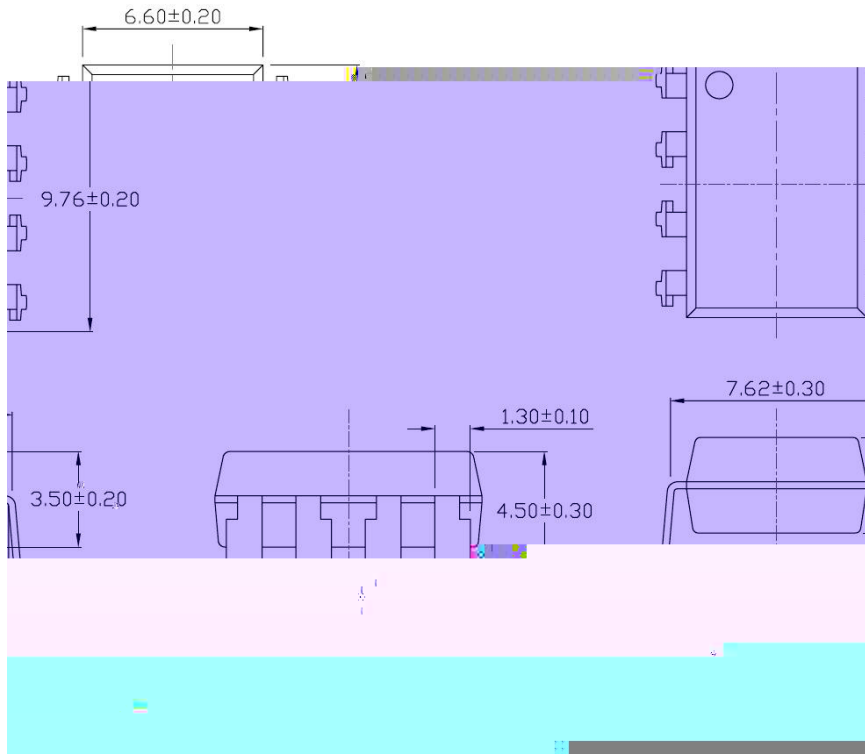

*XOOZLQJ PLO /HDG)RUPLQJ ± 7KURXJK +ROH

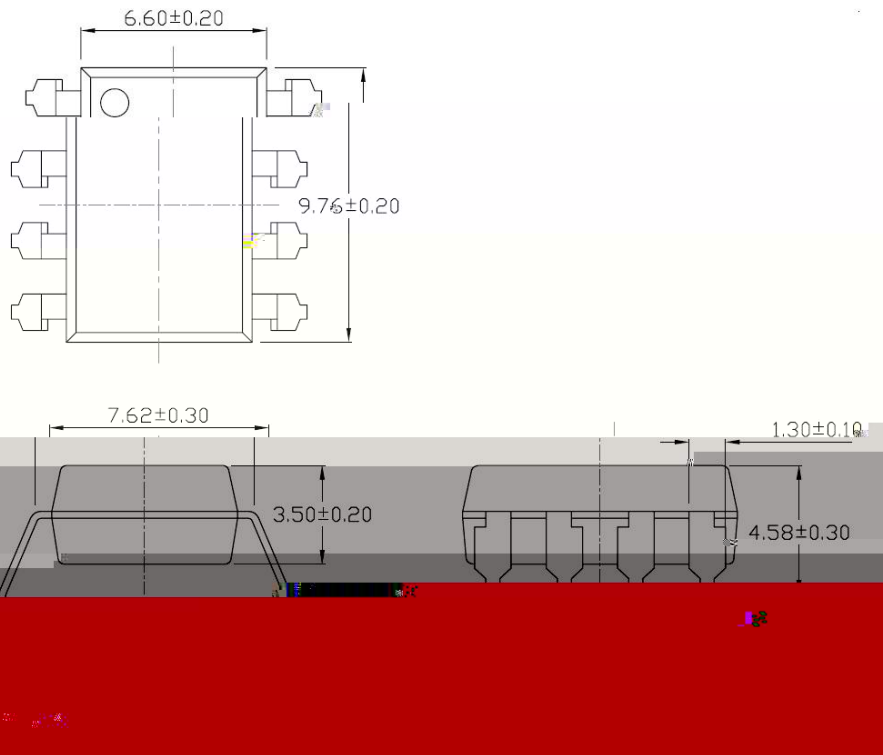

3\$&.\$*(',0(16,216LPHQVLRQV LQ PP XQOHVV RWKHUZI
6XUIDFH 0RXQW /HDG)RUPLQJ 6 7\SH

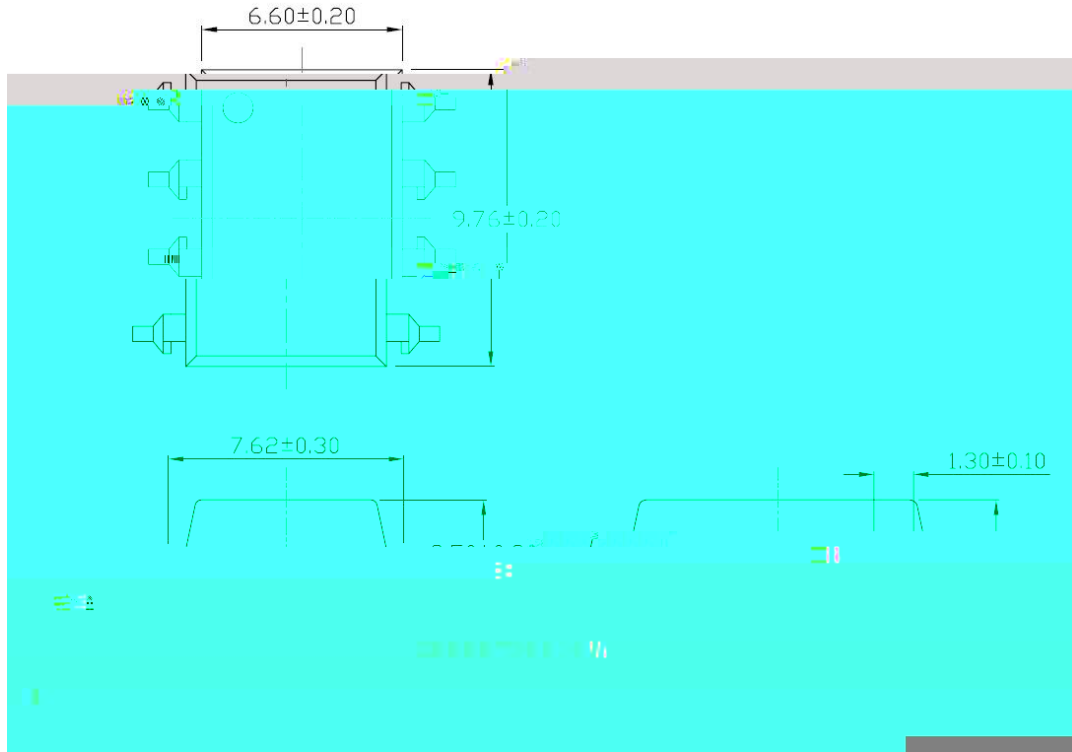

6XUIDFH 0RXQW /RZ 3URILOH /HDG)RUPLQJ 6

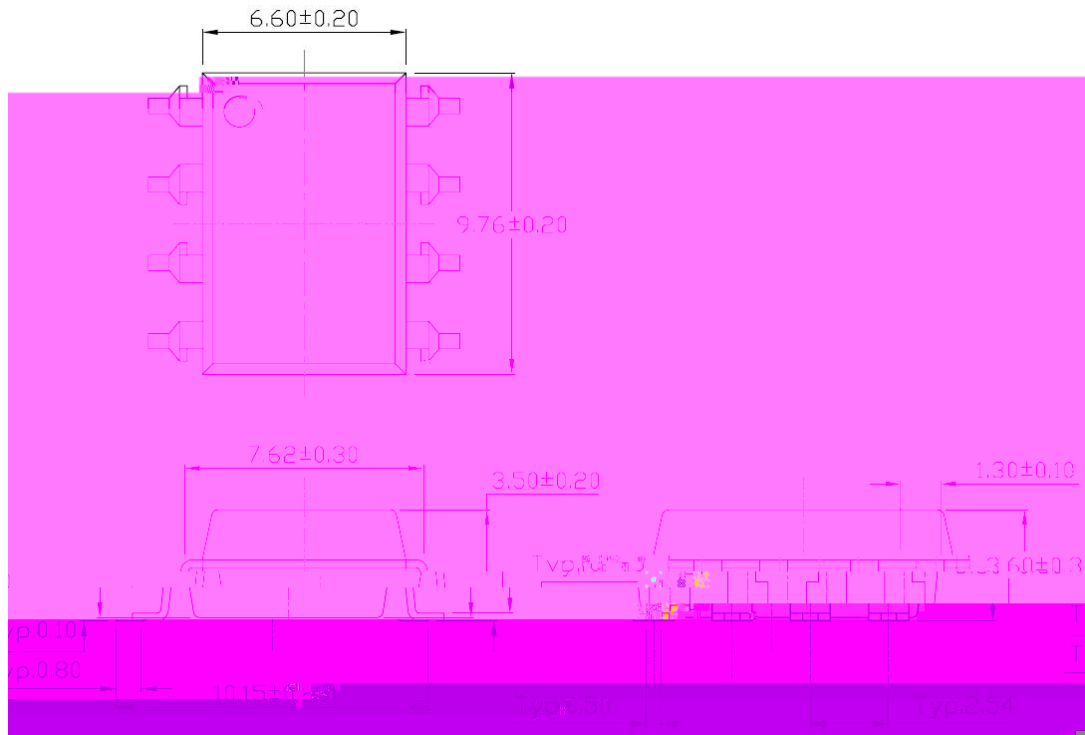

3\$&.\$*(',0(16,216LPHQVLRQV LQ PP XQOHVV RWKHUZI
 6XUIDFH 0RXQW *XOOZLQJ /HDG)RUPLQJ 6/0

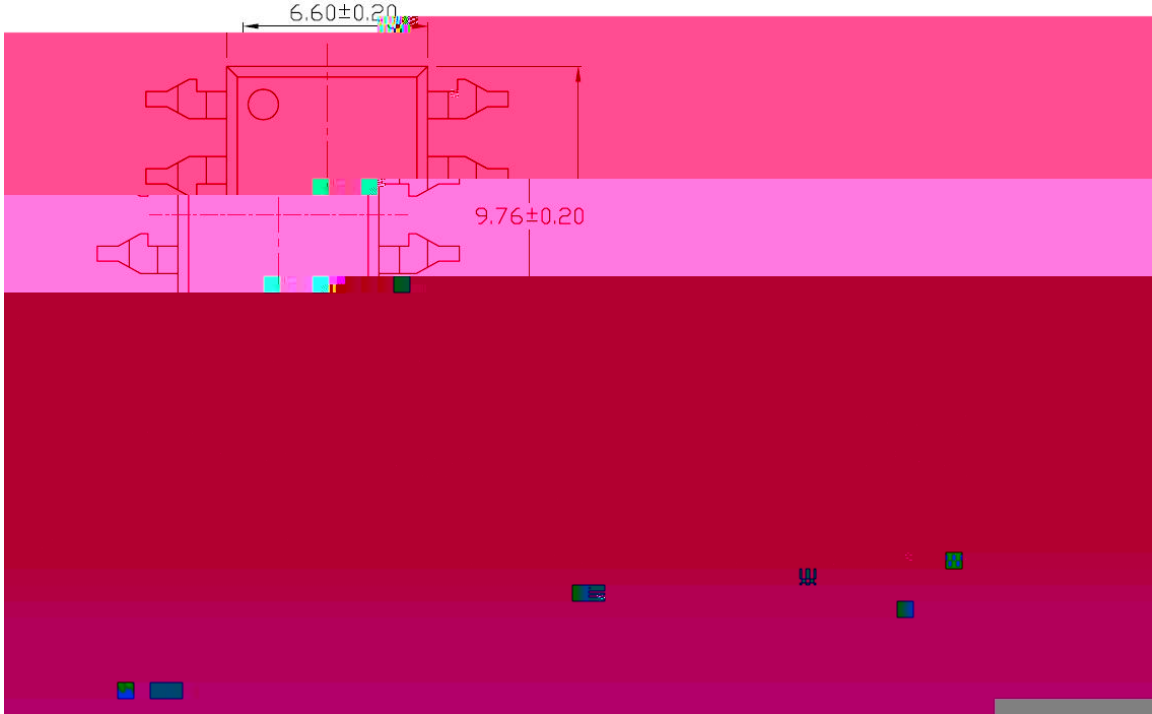

5HFRPPHQGHG 6R OGHVLDV M LQ PP XQOHVV RWKHU
 6XUIDFH 0RXQW /HDG)RUPLQJ 6XUIDFH 0RXQW /RZ 3

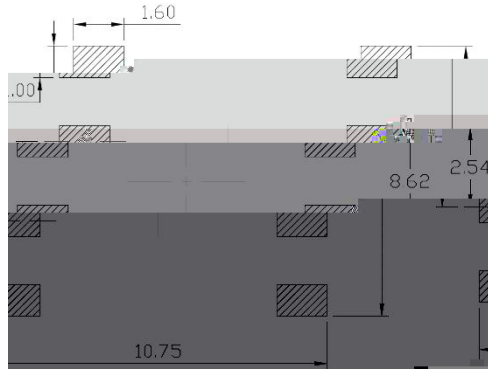

6XUIDFH 0RXQW *XOOZLQJ /HDG)RUPLQJ

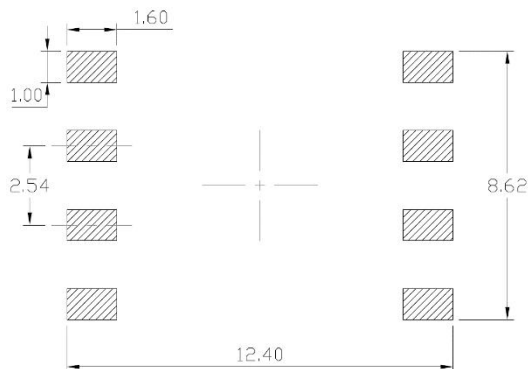

78% (63 (& ,) , & \$7, 2 1 6 QVLRQV LQ PP XQOHVV RWKHUZI

% 2 ; 6 3 (& ,) , & \$ 7 , 2 x 6 H 7 \ S H

, Q Q H U % R [

Label



2 X W H U % R [

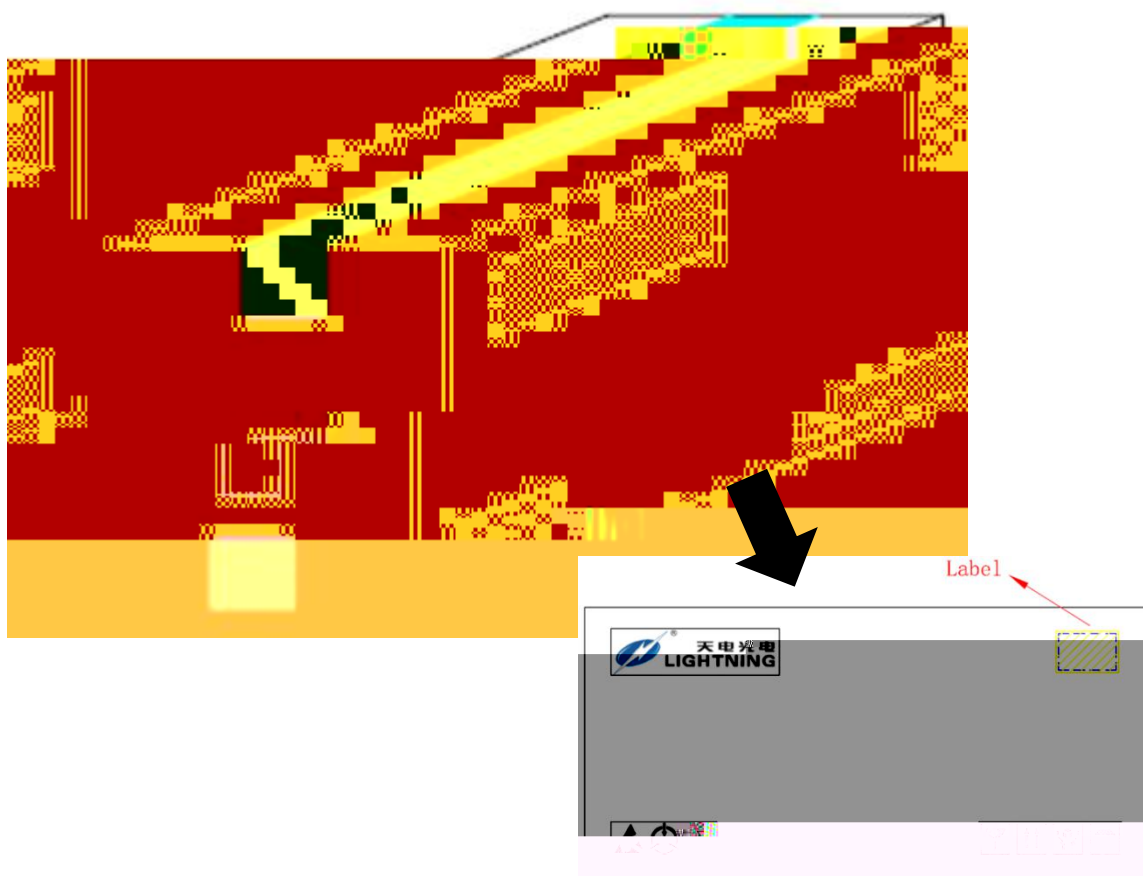

&DUULHU 7DSH 6SHIFLHQLFLRQLRQV XQOHVV RWKHU

& DUULHU 7 DSH 6 SHIFLIQVFLRWLRQV XQOHVV RWKHU

2 SWLRQ 6/0 7

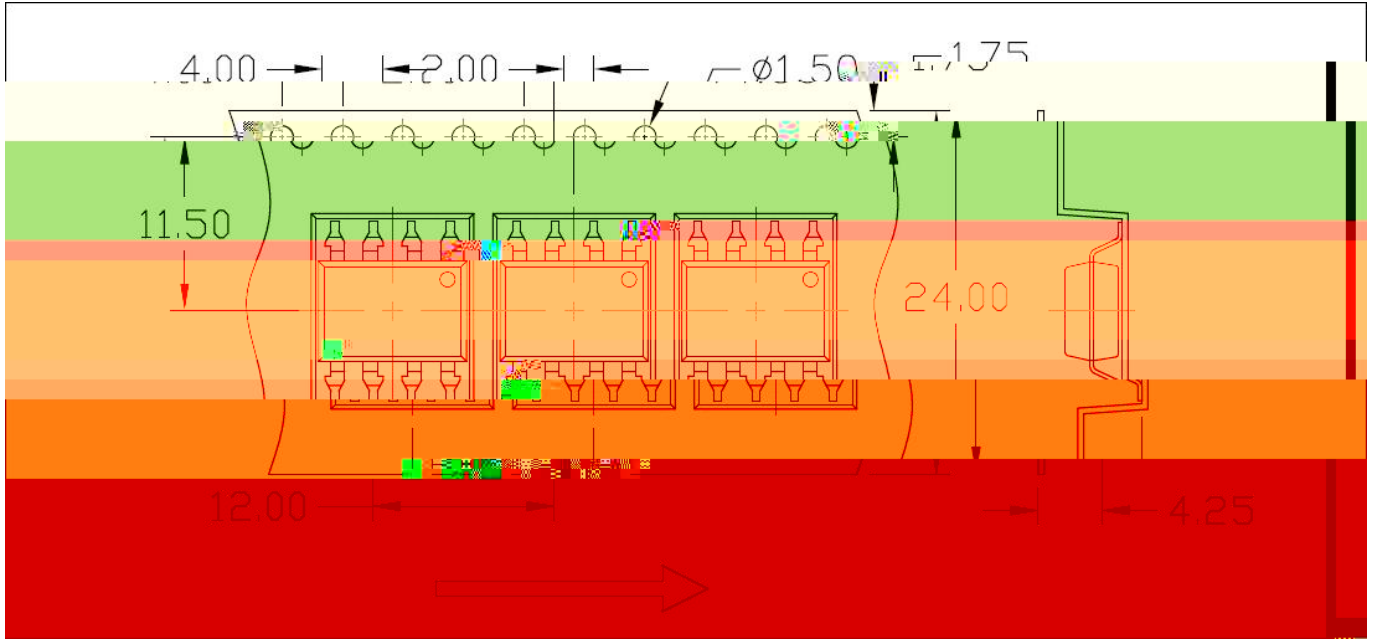

2 SWLRQ 6/0 7

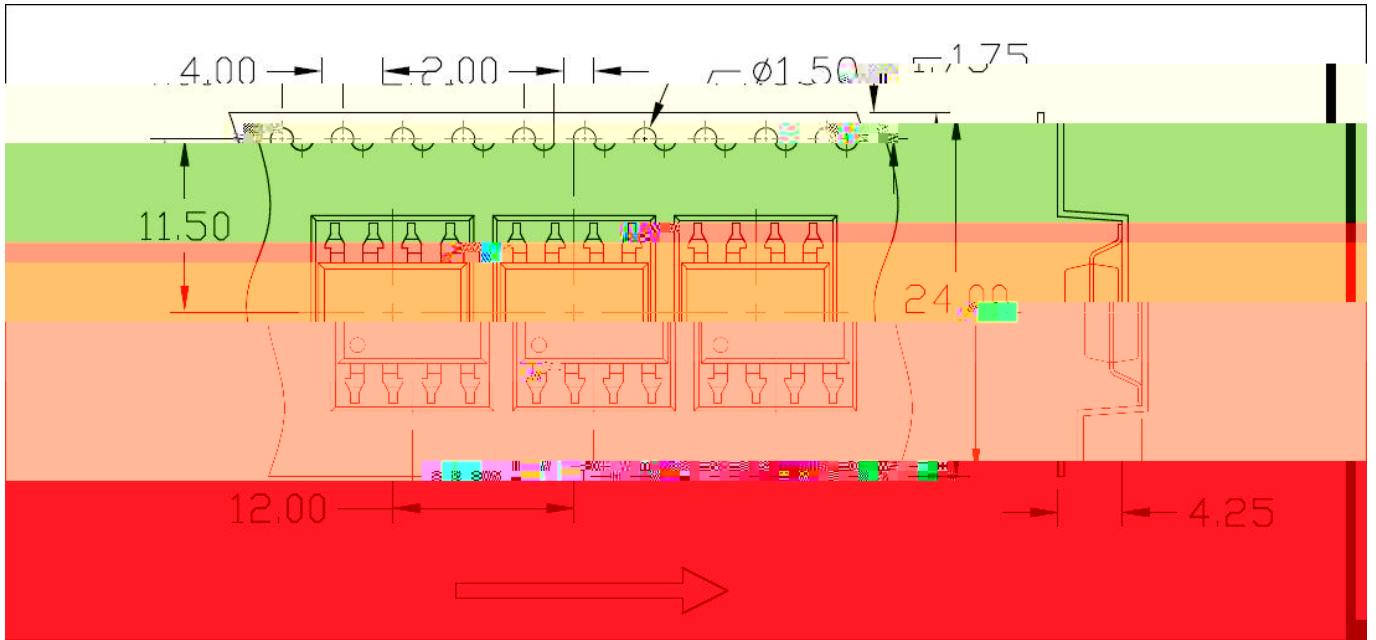

5 (/ 63 (& ,) , & \$ 7 , 2-1 6 HQVLRQV LQ PP XQOHVV RWKHUZL

2SWLRQ 6 2SWLRQ 6/

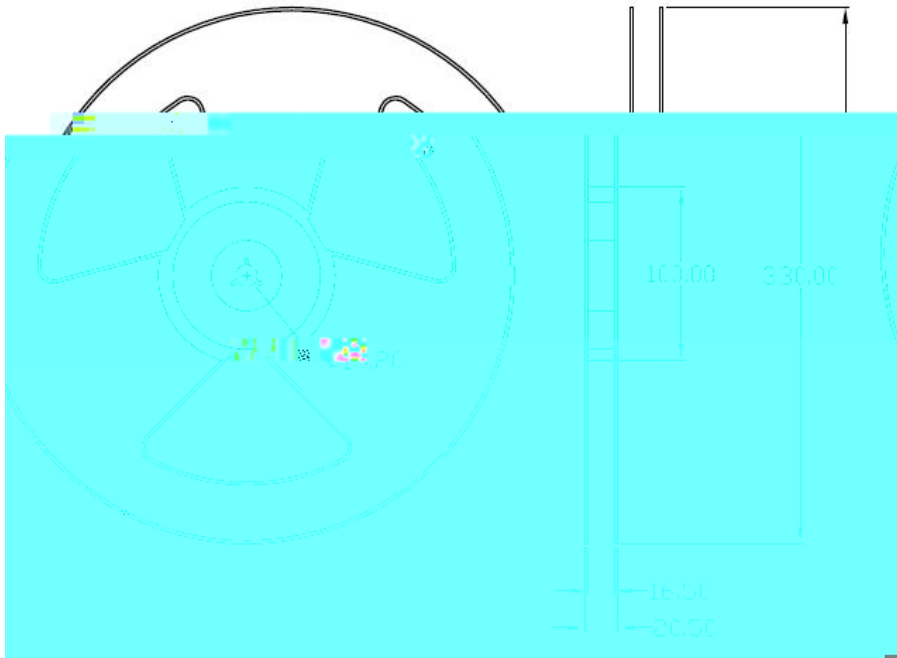



5HHO 7\SH

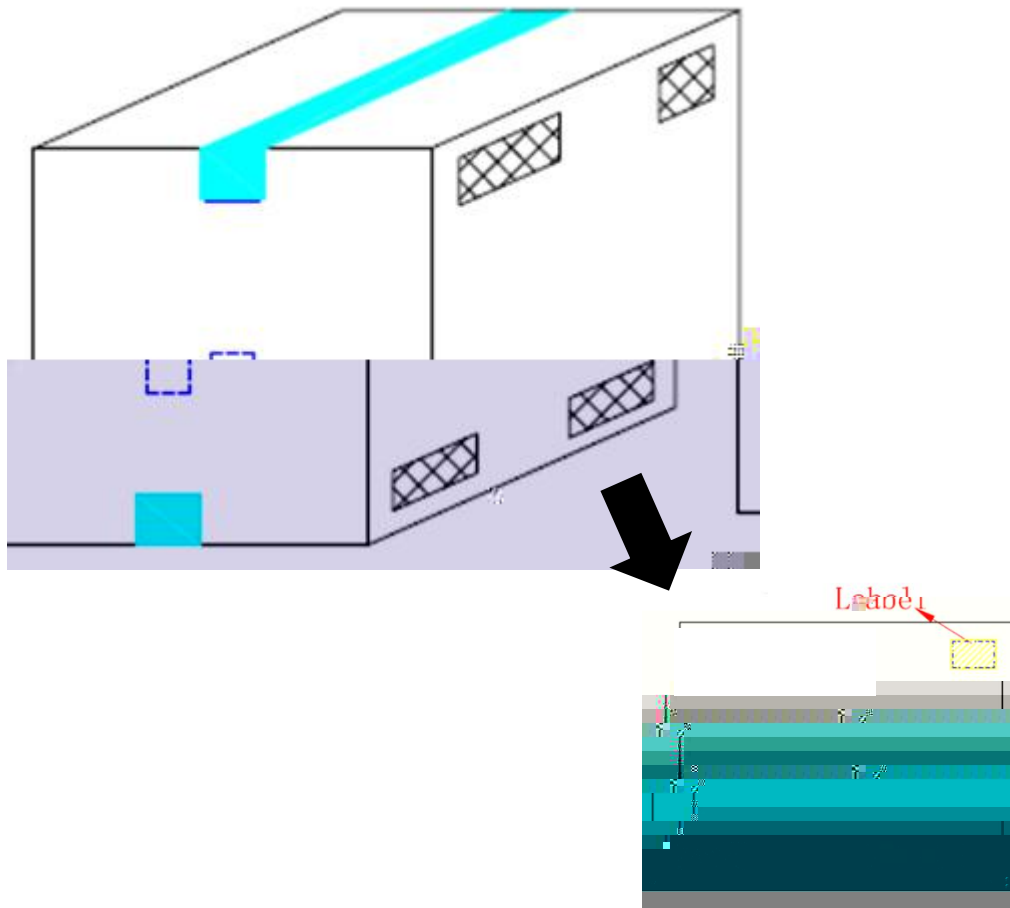

-2& 5 6HULHV

'& ,QSXW \$ *DWH 'ULYHU 3H

25'(5,1*\$1'0\$5.,1*,1)250\$7,21

0\$5.,1*,1)250\$7,21

-2&	&RPSDQ\ \$EEU
5	3DUW 1XPEHU
9	9'(2SWLRQ
<)LVFDO <HDU
\$	0DQXIDFWXULQJ &RGH
::	:RUN :HHN

25'(5,1*,1)250\$7,21

/\$%(/,1)250\$7,21

- 2 & 5 < = * 9

-2&±&RPSDQ\ \$EEU
5 ±3DUW 1XPEHU
< ±/HD)RU 2SWLRQ
0 6 6/ 6/0 1RQH
= ±7DSDQ\ \$EEU 2SWLRQ
* ±0DWH 2SWLRQ
* *UHHQRQH RQ *UHHQ
9 ±9' (

5()/2: ,1)250\$7,21

5()/2: 352),/(

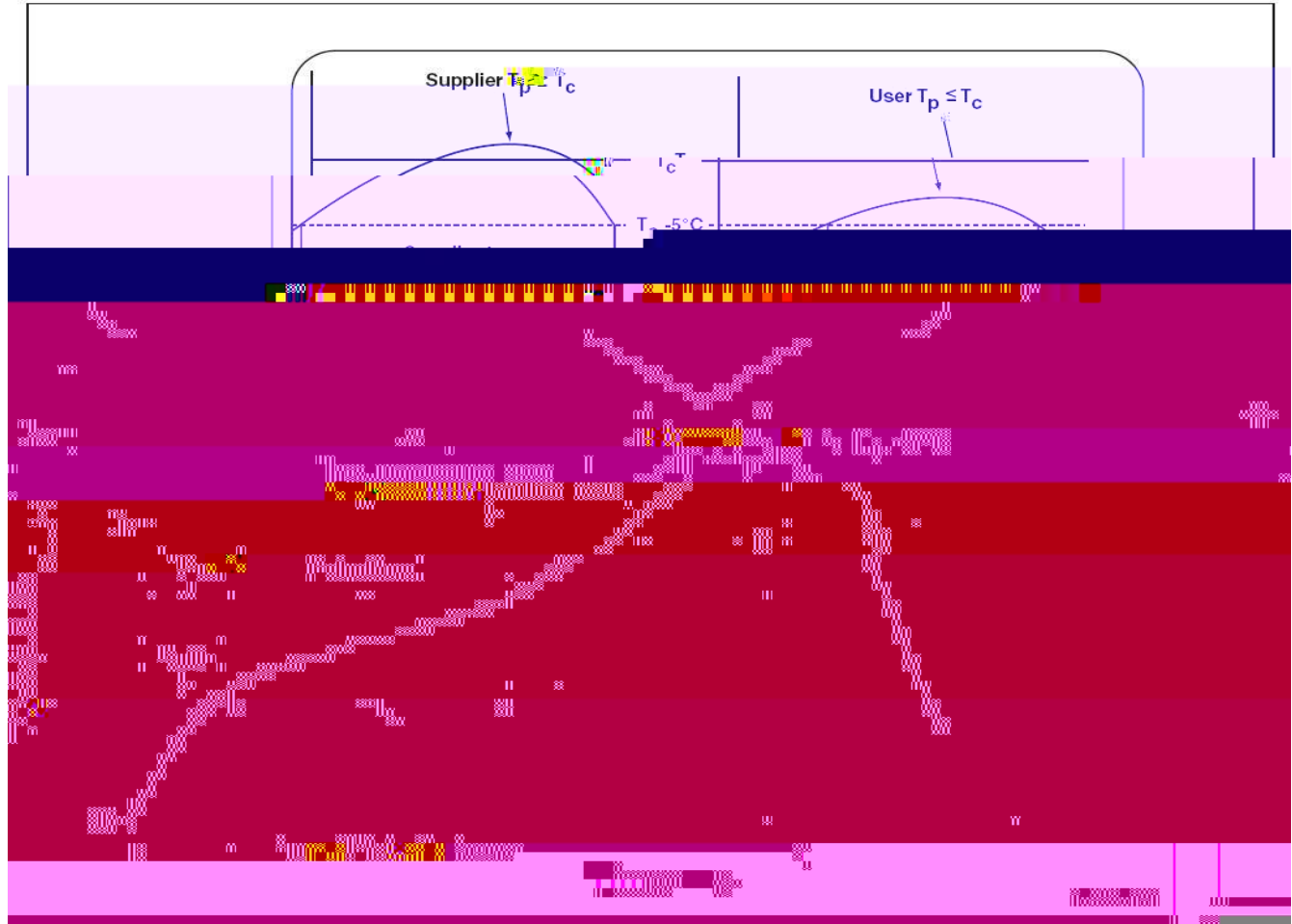

3URILOH)HDWX	6Q 3E \$VVHPEO\ 3	3E)UHH \$VVHPEO
7HPSHUDWXUH 0LQ		f &
7HPSHUDWXUH 0D[f &
7LPH WV IURP 7VPL	VHFRQGV	VHFRQGV
5DPS XS 5DWH W/	f & VHFRQG PD	f & VHFRQG PD
/LTXLGRXV 7HPSHU	f &	f &
7LPH W/ 0DLQWDLQ	± VHFRQG	± VHFRQG
3HDN %RG\ 3DFNDJH	f & f & f &	f & f & f &
7LPH W3 ZLWKLQ j	VHFRQGV	VHFRQGV
5DPS GRZQ 5DWH 7	f & VHFRQG PI	f & VHFRQG PI
7LPH f & WR 3HDN 7H	PLQXWHV PD	PLQXWHV PD

